

GUARANTEE

This product is guaranteed against defects in workmanship and materials subject to fair wear and tear for a minimum period of two years from date of installation and assumes no liability for any of the following:

- Improper installation or failure to follow installation instructions.
- Failure due to improper maintenance.
- Indirect or inconsequential loss or damage.
- Cost of removal and/or replacement.
- Cost of freight and/or traveling time.

HANDING OF DOOR - BRITISH STANDARDS

RIGHT-HAND DOOR



LEFT-HAND DOOR



NOTE:

CASE DOES NOT NEED TO BE OPENED AT ANY TIME TO CHANGE FUNCTION OR HANDING OF LOCK

LOCK STATUS

Check Lock Status before installation and change if required.

To UNLOCK - Remove cylinder hole dust cap and use a small flat blade driver to lift locking bar.

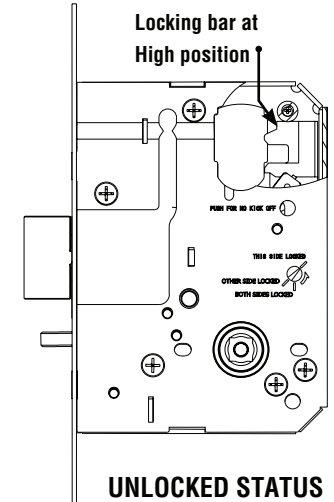
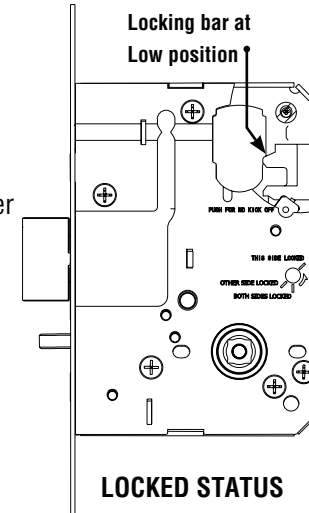

LOCK FUNCTIONS

Depending on the locking function required it can be set to any vestibule or combination lock status. To change the locking function, it is necessary to rotate the locking wedge with a small flat blade driver supplied to desired location. Refer to lock status on lock cover for detail.

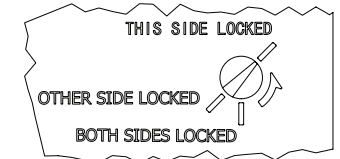
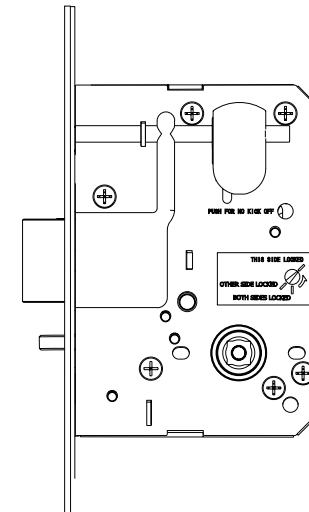

THIS SIDE LOCKED
for Left Hand Door

OTHER SIDE LOCKED
for Right Hand Door

BOTH SIDES LOCKED
Warning! Not suit for Escape Door

EZ-CAM
Function: Cam Locks/Unlocks outside handle. outside handle free when unlocked. Inside handle free

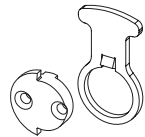

EH-CAM
Function: Cam enables latch bolt to be held retracted. Rotate key/snib and press in latch to keep retracted and remove key. Rotate key/snib in opposite direction to release

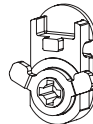

EX-CAM
Function: Cam retracts bolt. Outside handle rigid. Inside handle free



EZ-ADAPTOR
Function: Allows turnsnib to lock and unlock door

EW-CAM
Function: Cam links with turn adaptor to unlock. Outside handle free when unlocked. Inside handle free

EX-ADAPTOR
Function: Allows turnsnib to retract latch

LOCK FUNCTIONS - VESTIBULE HANDING

Determine if kick off (anti-lockout) function is required.

TO ENABLE KICK OFF FUNCTION

1. Ensure lock is in LOCKED STATUS
2. Depress slide where marked "PUSH FOR KICK OFF" with a small pin.

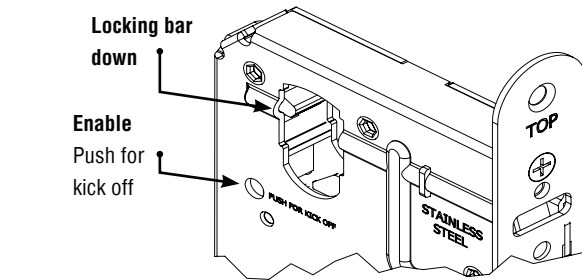

TO DISABLE KICK OFF FUNCTION

1. Ensure lock is in LOCKED STATUS
2. Depress slide where marked "PUSH FOR NO KICK OFF" with a small pin.

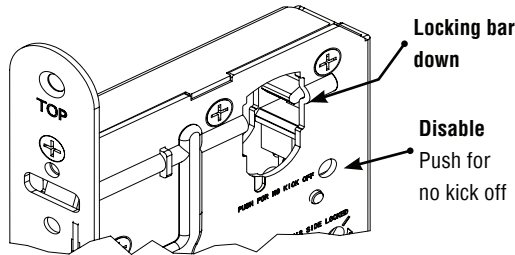

TURN ADAPTOR INSTALLATION

Turn adaptors are captive and must be installed correctly for proper operation.

1. Determine handing for adaptor.
2. Put lock into LOCKED STATUS by moving locking bar to down position.
3. Insert adaptor as illustrated, ensuring the cam plate is engaged in with locking bar.
4. Insert retaining pin and test operation, ensuring the locking bar is operating up and down with operation of cam.
5. Lock can now be left in UNLOCKED STATUS, locking bar UP until fully installed in door.

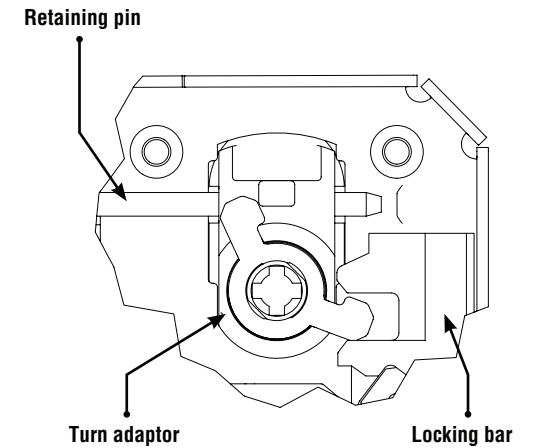

MORTICE INSTRUCTIONS

1. Determine center line and height of installation on door.
2. Place template on door and align with center line, mark and mortise area to desired depth.
3. Clean out mortise and insert lock case to check desired cavity size.
4. Fold template, align on door to center lines, mark and drill desired cylinder, spindle and screw holes from both sides.
5. Clean out mortise and install lock.
NOTE: REMOVE LOCK FROM DOOR BEFORE DRILLING

SPINDLE INSTALLATION

1. Attach spring to spindle.
2. Install spindle(s) into lock.

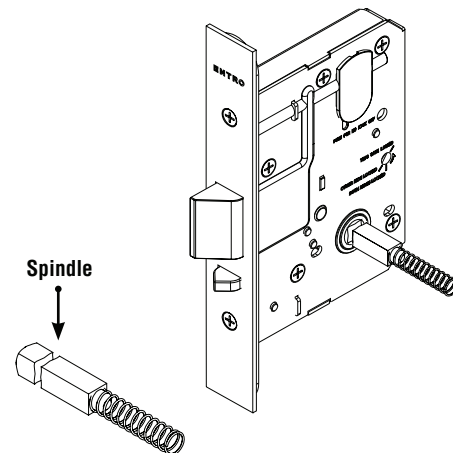

CYLINDER INSTALLATION

1. Remove plastic cylinder cover cap with small flat blade screwdriver.
2. Install lock in mortise and insert cylinder.
3. Insert retaining pin to secure cylinder. Ensure pin is flush with front plate.
4. Install face plate with two metal thread screws provided.

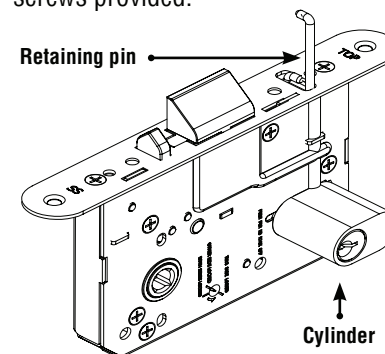

STRIKE INSTALLATION

1. Mark out frame for strike and strike box if applicable.
2. Install strike with screws provided.

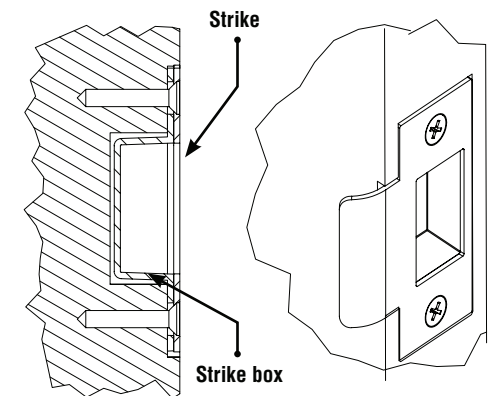

Mortise Lock Installation

1. Fold mortise lock template on door edge with lever spindle line at desired height (approx 1000mm from floor). Mark holes ready for drilling. Drill 2mm pilot holes for the furniture **from both sides of the door**.

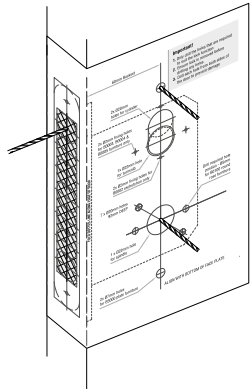

2. Only drill the holes that are required to suit the lock function. Drill each hole from both sides of the door to prevent damage. Insert and fix mortise lock ensuring mortise lock is functioned to desired setup. The faceplate can be fixed later if cylinder or adaptors need to be installed.

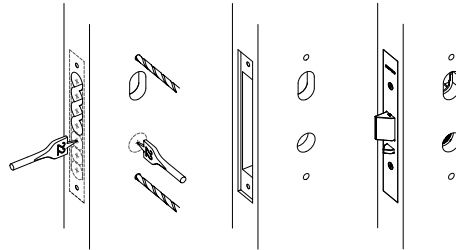

Lever Handing

3. Hand the lever according to the mounting side by removing the (a.) cam stopper screw and rotating the lever. Refasten the cam stopper screw when lever is in desired position.

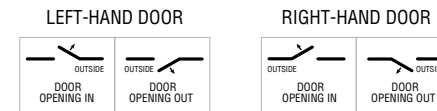
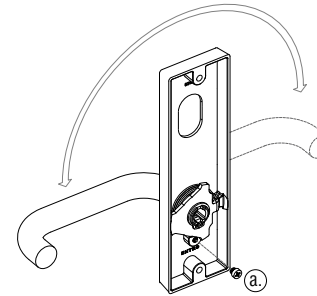

Turnsnib Handing - B3800/B3900 Only

4. Adjust position of screw stoppers on back of B3800 (DDA turnsnib) for handing. Adjust screw stoppers for the B3900 (emergency release) to the opposite handing of the B3800 plate. Eg. B3800 – 45 Deg LH & B3900 – 45 Deg RH Setup.

45° ROTATION SETTING & HANDING (A0100SSSM)

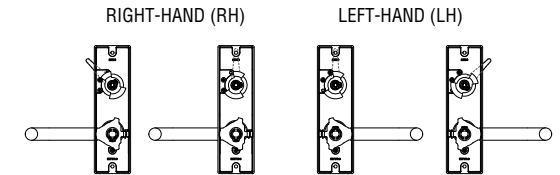

90° ROTATION SETTING & HANDING

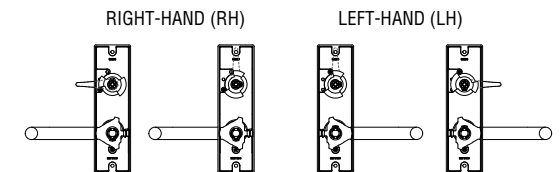

Fixing Screw Preparation

5. Place internal plate against the door and insert fixing screws provided through the door fixing holes. Ensure fixing screws are protruding min. 5mm and max. 8mm past the door face and cut to size if necessary.

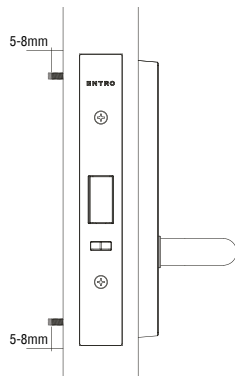

Turnsnib Setup - B3300 Only

6. Place B3300 turnsnib plate against the door with the turnsnib tailpiece against the edge of the door. Mark and cut the tailpiece 5mm from the centre of the mortise lock as shown.

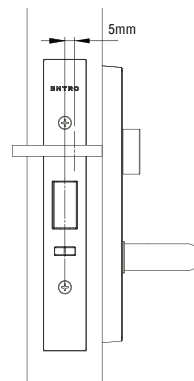

Turnsnib Setup - B3800/B3900 Only

7. Place B3900 external plate against the door and insert star spindle (a.) provided through the door engaging both the Turn Adaptor and B3900 emergency release (b.) Mark and cut down spindle to 9mm from the face of the door.

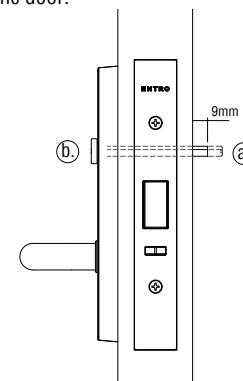

Complete Setup

8. Insert spindle/s (a.) into lock as required, ensuring the spindle spring is attached to the rear of the spindle. If fitting B3800/B3900, ensure the Mortise Lock is locked and the B3800 Turn Snib & B3900 emergency release is in (b.) locked (diagonal/horizontal) position before connecting the plates with the star spindle (c.). Lightly fasten with the Qty 2 fixing screws provided. Check levers are both horizontal and test out anti-lockout function if necessary before firmly tightening fixing screws.

